

fornace
brioni

Scenografica

DESIGNED BY
CRISTINA CELESTINO

La collaborazione di Cristina Celestino con Fornace Brioni si rinnova portando in scena un nuovo capitolo progettuale: Scenografica.

La collezione si ispira al lavoro dei grandi scenografi del Barocco italiano, conosciuti per la creazione di architetture magnifiche ed effimere.

Il progetto ha come fil rouge il tema dell'illusione, che nel periodo barocco diventa protagonista dell'esperienza teatrale: finzione e arte si incontrano sul palcoscenico per creare stupore e meraviglia nel pubblico.

Cristina Celestino continues her collaboration with Fornace Brioni, creating a new chapter: Scenografica. The collection is based on the work of the great set designers of the Italian Baroque, known for their magnificent temporary works of architecture. The red thread is the theme of illusion, which in the Baroque era was the true protagonist of the theatrical experience: artifice and art meet on the stage to generate amazement and wonder in the audience.

The collection is based on the work of the great set designers of the Italian Baroque.



Tra i riferimenti più illustri, il lavoro della famiglia Galli da Bibbiena, che tra la metà del '600 e la fine del '700 operò nel mantovano dove si trova la storica fornace Brioni. La famiglia si distingue per la creazione di autentici capolavori, come il Teatro Scientifico a Mantova e la Chiesa di Sant'Antonio Abate a Villa Pasquali.

Among the most illustrious references, there is the work of the Galli da Bibbiena family, which from the middle of the 17th century to the end of the 18th century, worked in the Mantua area, home of the historic Fornace Brioni. This family stood out for the creation of true masterpieces, like the "Scientific Theater" in Mantua and the church of Sant'Antonio Abate at Villa Pasquali.

Prendendo spunto da queste creazioni, dai segni grafici ricorrenti, da una palette cromatica varia ed importante, la designer elabora un processo di astrazione profonda e crea una collezione composta da pavimenti, rivestimenti e partizioni murarie contemporanee ed evocative.

Taking her cue from these inventions with their recurring graphic signs and a variegated, impressive range of colors, the designer has developed a process of penetrating abstraction, creating a collection composed of contemporary, evocative floors, facings and partitions.

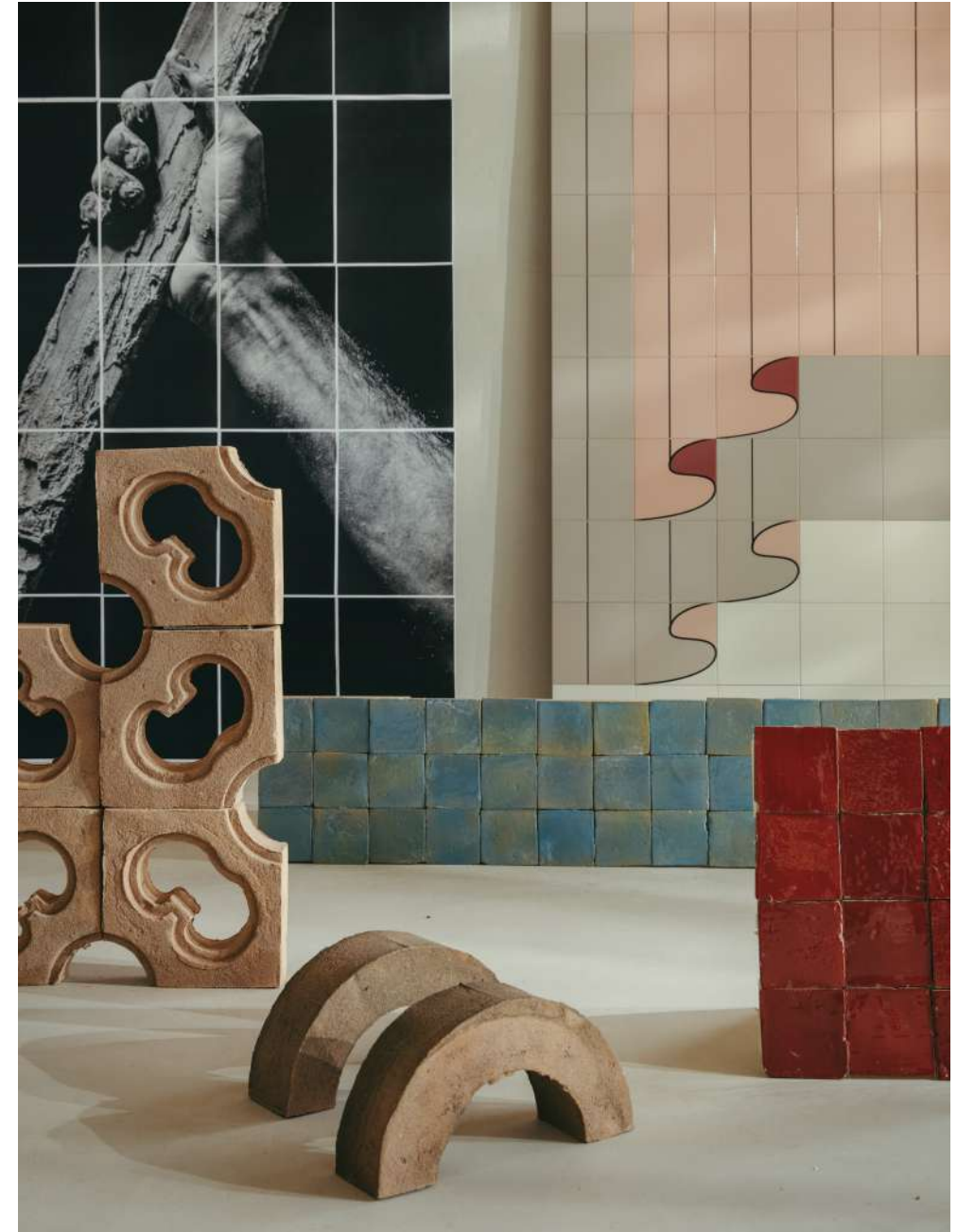

From above: ILLUSIONE wall covering - ALLEGORIA wallpartition, cotto Rosato QUADRATO, wall covering, glossy Red, glossy Blue
Left page: TRIONFO, flooring, cotto Bianco, cotto Grigio 02, cotto Variegato 09

Capriccio

Pavimento - Flooring

CAPRICCIO - SCHEDA TECNICA - TECHNICAL INFOS

	MISURE	SPESSORE
	20x29 cm	2 cm
	21x27 cm	2 cm
	19x6 cm	2 cm
	30x33 cm	2 cm
	8x9 cm	2 cm

Schemi di posa · Laying schemes

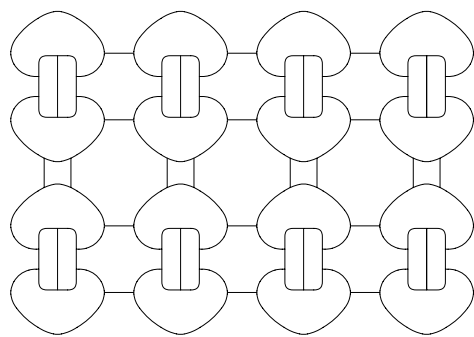

Schema di posa

Proposte colori · Colours Proposals

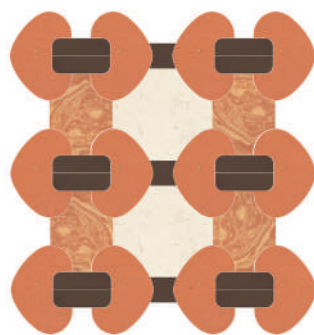

V01
Cotto rosato, cotto bianco,
cotto moka, cotto variegato 07

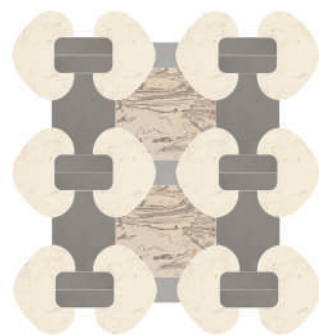

V02
Cotto bianco, cotto grigio 00,
cotto grigio 01,
cotto variegato 08

Colori · Colours

Cotto rosato	Cotto moka	Cotto bianco	Cotto variegato 07	Cotto grigio 00	Cotto grigio 01	Cotto variegato 08

*All the rest of colours are part of the technical infos of Catalogue 1.



From above: CAPRICCIO flooring, cotto Rosato, cotto Bianco, cottoMoka, cotto Variegato 07

Capriccio

Rivestimento Mosaico - Mosaic Wall covering

MISURE SPESSORE

	2,8x4 cm	0,9 cm
	1,5x2,6 cm	0,9 cm
	3x3,7 cm	0,9 cm
	3,8x4,4 cm	0,9 cm
	1,3x1,5 cm	0,9 cm

Schemi di posa · Laying schemes

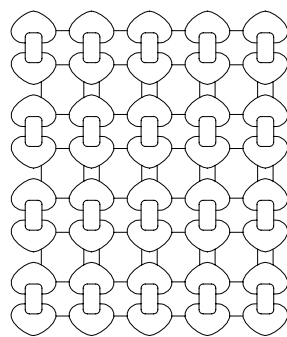

Schema di posa

Mosaico assemblato su rete 25x28 cm · Mosaic assembled on mesh of 25x28 cm

Proposte colori · Colours Proposals

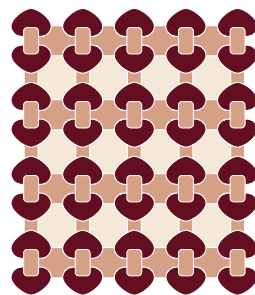

V01
Pink sand, ivory, cherry

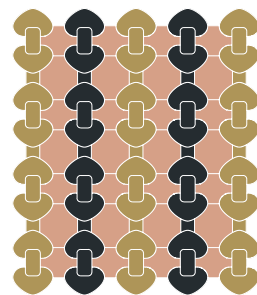

V02
Mustard, black, pink sand

Colori · Colours

Lucidi - Glossy · Opachi - Matt



*All the rest of colours are part of the technical infos of Catalogue 1.

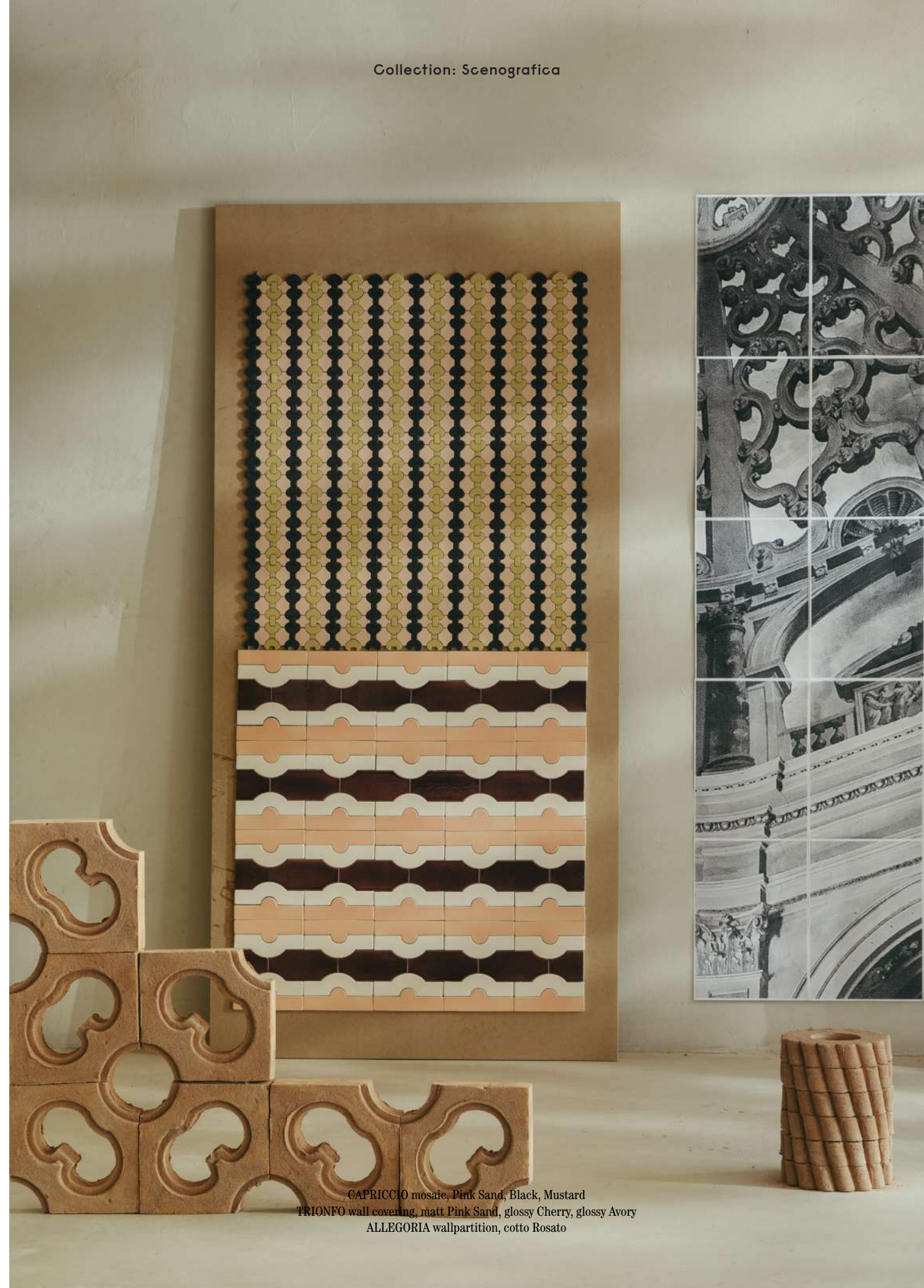

CAPRICCIO mosaic, Pink Sand, Black, Mustard
TRIONFO wall covering, matt Pink Sand, glossy Cherry, glossy Ivory
ALLEGORIA wallpartition, cotto Rosato

Trionfo

Pavimento - Flooring

TRIONFO - SCHEDA TECNICA - TECHNICAL INFOS

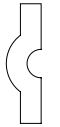
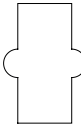
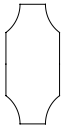
	MISURE	SPESSORE
	13x45 cm	2 cm
	30x45 cm	2 cm
	20x45 cm	2 cm

Schemi di posa · Laying schemes

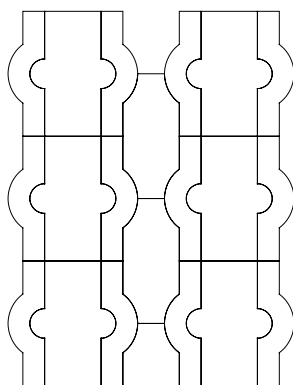

Schema di posa

Proposte colori · Colours Proposals



V01
Cotto variegato 09,
cotto bianco, cotto grigio 02

V02
Cotto bianco,
cotto grigio 01, cotto
variegato 01

Colori · Colours

Cotto bianco	Cotto grigio 02	Cotto variegato 09	Cotto grigio 01	Cotto variegato 01
				

*All the rest of colours are part of the technical infos of Catalogue 1.



TRIONFO flooring, cotto Bianco, cotto Grigio 02, cotto Variegato 09
ALBERTI from Gonzaga collection, wall covering, cotto Grigio 01 - QUADRATO, wall covering, matt Blue 02, glossy Blue

Trionfo

Rivestimento - Wall covering

MISURE SPESSORE

	5,7x18 cm	0,8 cm
	5,7x18 cm	0,8 cm
	7,8x18 cm	0,8 cm

Schemi di posa · Laying schemes

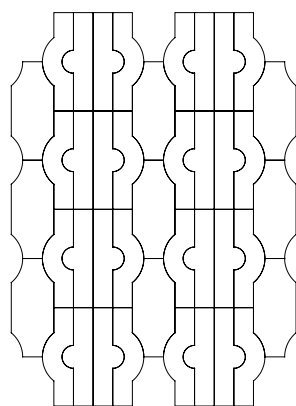

Schema di posa

Proposte colori · Colours Proposals

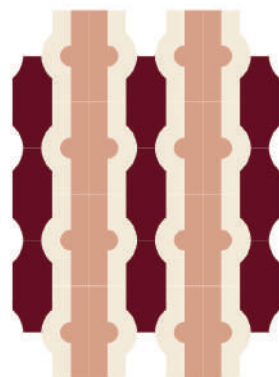

V01
Pink sand, cherry, avory

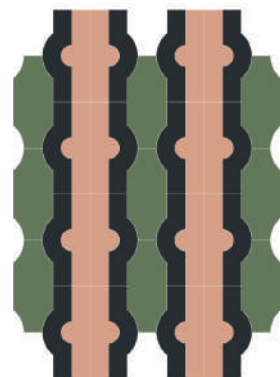

V02
Pink sand, green edera,
black

Colori · Colours

Lucidi - Glossy · Opachi - Matt

Pink sand	Avory	Cherry	Green edera	Black

*All the rest of colours are part of the technical infos of Catalogue 1.

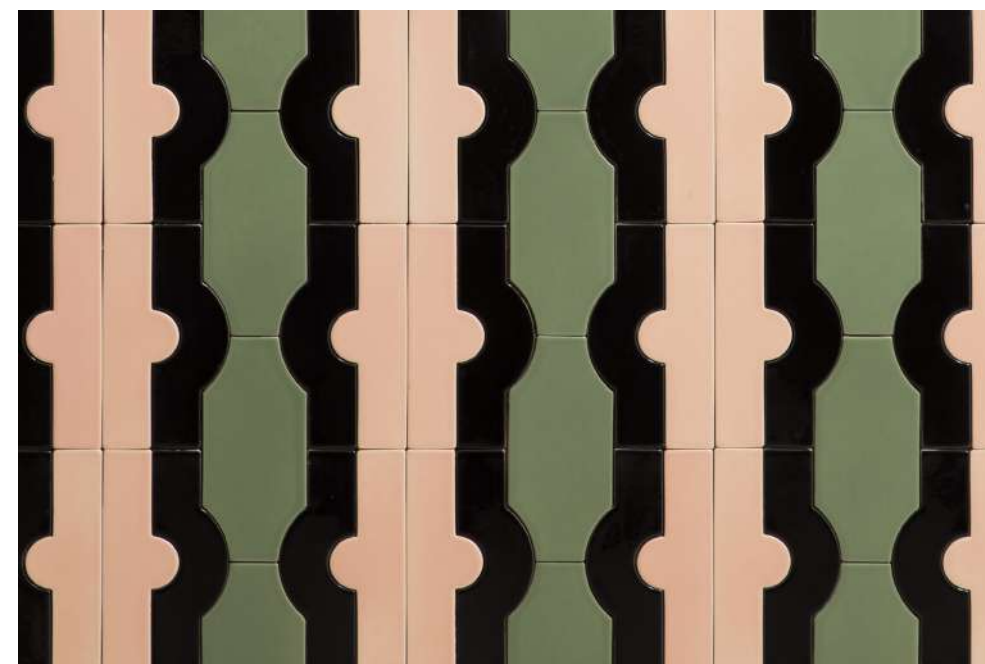
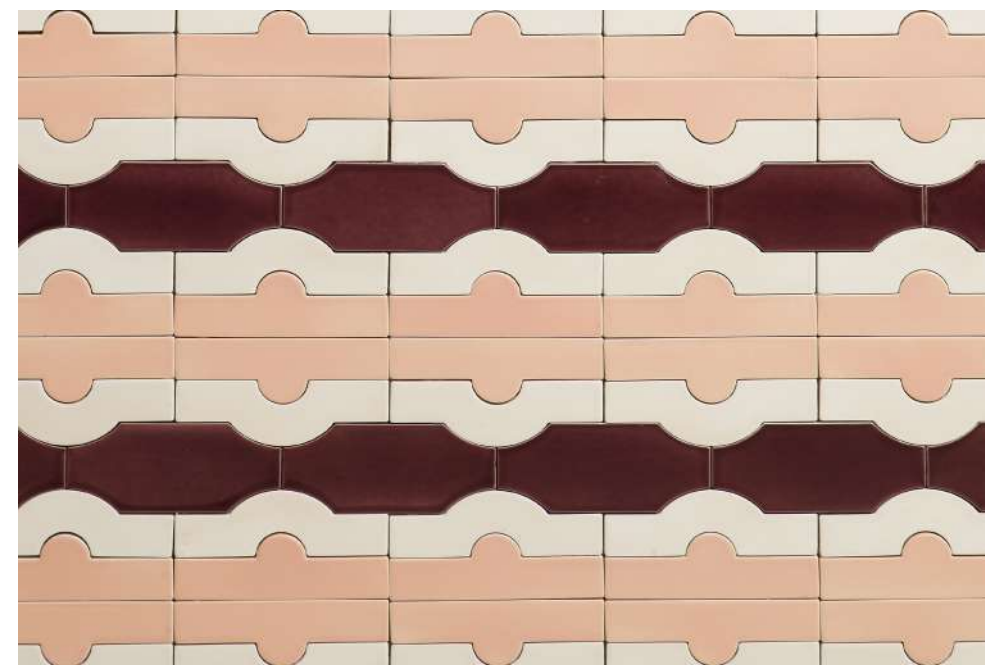

Up image: TRIONFO wall covering, matt Pink Sand - glossy Cherry - glossy Avory
Bottom image: TRIONFO wall covering, matt Pink Sand - matt Green Edera - glossy Black

Illusione

Rivestimento - Wall covering

MISURE SPESSORE

20x20 cm 0,8 cm

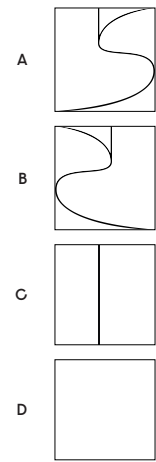

Schemi di posa · Laying schemes

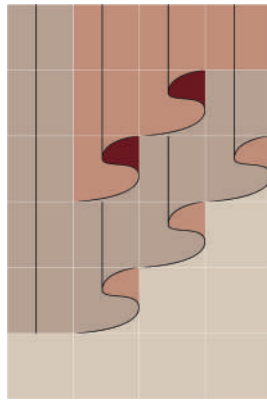

Schema di posa Ø1

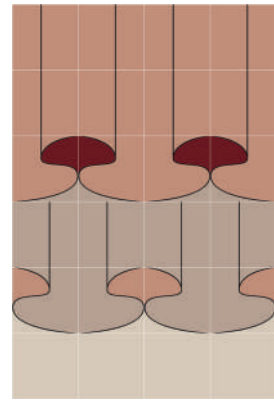

Schema di posa Ø2

Colori · Colours

Serigrafia - Silk-screen printing

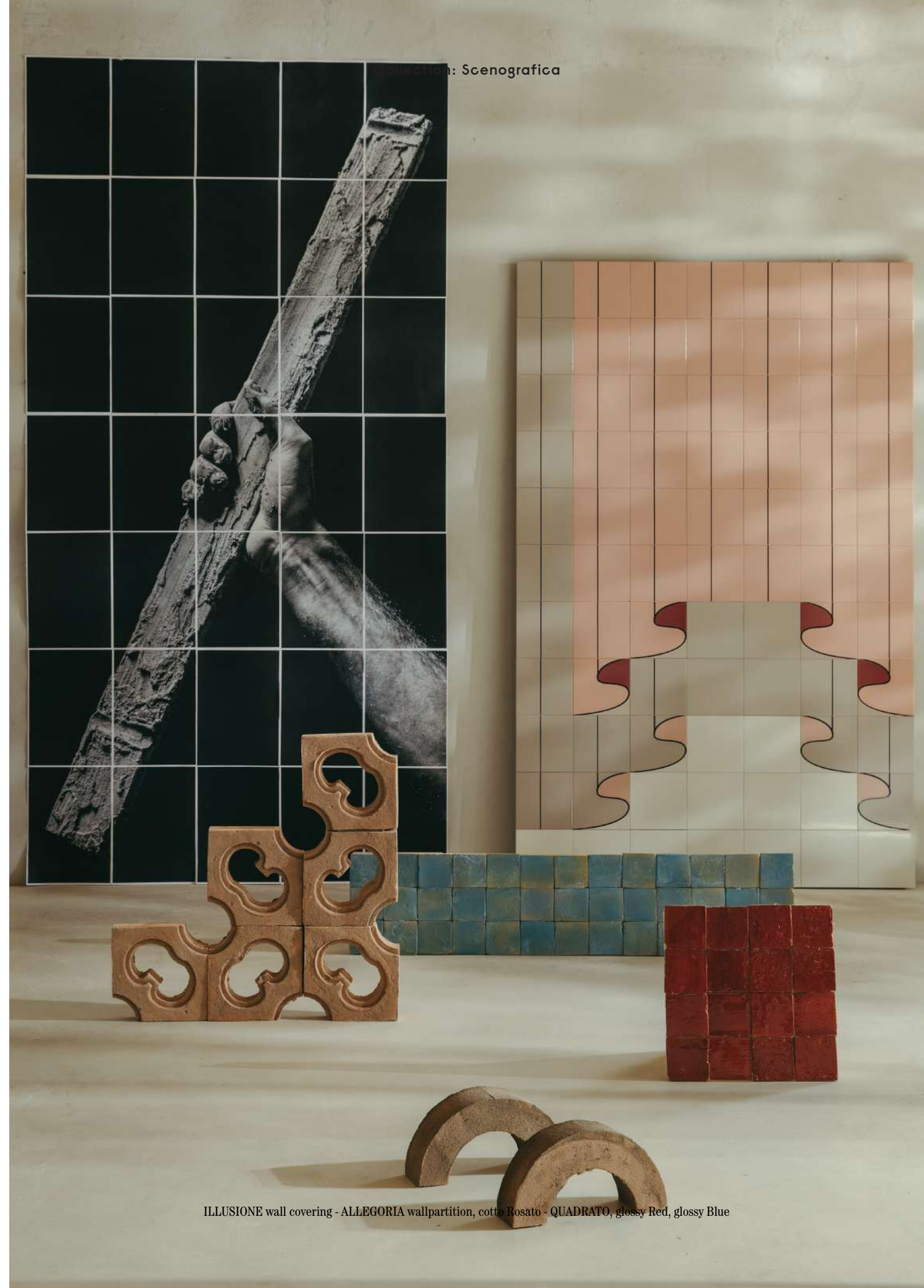
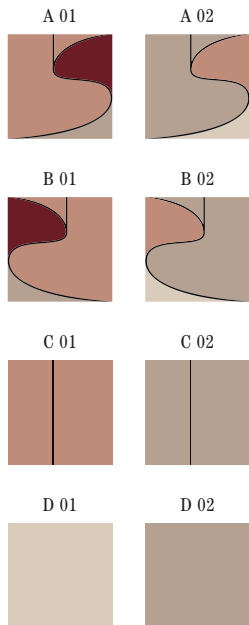

Collection: Scenografica

ILLUSIONE wall covering - ALLEGORIA wallpartition, cotto Rosato - QUADRATO, glossy Red, glossy Blue

Allegoria

Gelosie / partizioni murarie - Wallpartition**

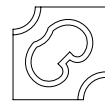

MISURE SPESSORE

25x25 cm 8 cm

Schemi di posa · Laying schemes

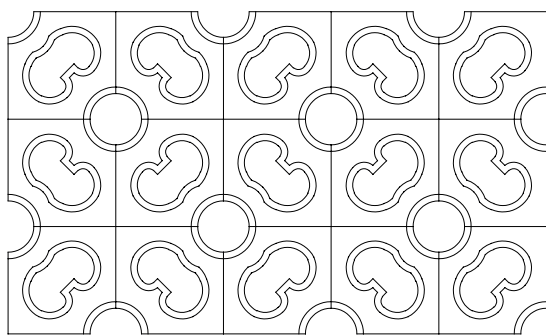

Schema di posa

Proposte colori · Colours Proposals

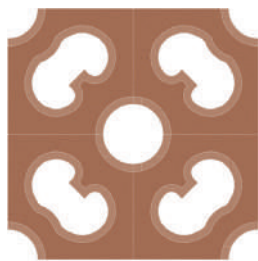

V01
Cotto rosato

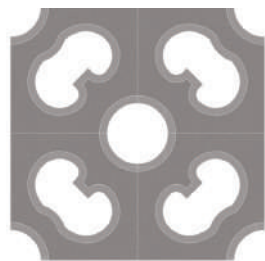

V02
Cotto grigio 01

Colori · Colours



*All the rest of colours are part of the technical infos of Catalogue 1.
** The elements are not self-supporting - The bas relief is on one side only.

ALLEGORIA - SCHEDE TECNICHE · TECHNICAL INFOS



ALLEGORIA, wallpartition, cotto Rosato

Sabbioneta

Gelose / partizioni murarie - Wallpartition**

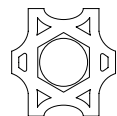

MISURE SPESSORE

28x29 cm 8 cm

Schemi di posa · Laying schemes

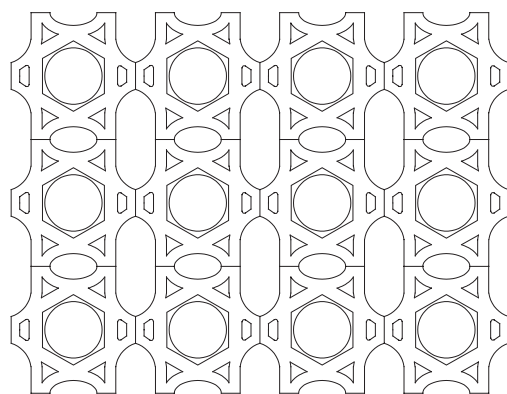

Schema di posa

Proposte colori · Colours Proposals

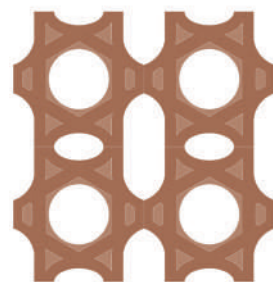

V01
Cotto rosato

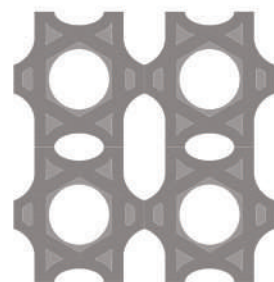

V02
Cotto grigio 01

Colori · Colours



*All the rest of colours are part of the technical infos of Catalogue 1.
** The elements are not self-supporting - The bas relief is on one side only.



From above: ROCAILLE* from Giardino delle Delizie collection, wall covering, glossy Earth 00, cotto Rosato, glossy Cherry

*ROCAILLE is a registered design

COLOPHON

Scenografica
©Fornace Brioni 2019

Concept and art direction
Cristina Celestino

Graphic design concept
Cecilia Cappelli

Photography
Mattia Balsamini

fornace
brioni

Fornace Brioni
Via/Strada Ronchi 77
46023 Gonzaga, Mantova

+39 0376 58142
brioni@fornacebrioni.it
fornacebrioni.it